



333 Bayview Avenue
Amityville, New York 11701
For Sales and Repairs, (800) 645-9445
For Technical Service, (800) 645-9440
Publicly traded on NASDAQ Symbol: NSSC

© NAPCO 2005

NAPCO FREEDOM F-TPBR TOUCHPAD INSTALLATION INSTRUCTIONS

WI1450 10/05

GENERAL DESCRIPTION

The NAPCO Freedom Deadbolt-Activated Home Protection System, a revolutionary new concept in residential security, combines intuitive interactive arming with a passive disarming scheme, providing a system which is not only effortless to use, but also virtually false alarm resistant during the arming and disarming sequences.

In addition to the primary F-TP Touchpad, the F-TPBR Touchpad provides a convenient second keypad through which the system can be armed and disarmed. The F-TPBR Touchpad is designed to be located at a distance from the primary Exit/Entry area, such as a bedroom, and allows arming with exterior AND interior protection on while staying home.

The F-TPBR Touchpad allows "Night Arming", which protects all areas of the premises (perimeter and interior) but deactivates the F-TPBR Touchpad PIR motion sensor. Night Arming allows increased protection while maintaining the false alarm reduction benefits of the Freedom system.

The system is armed with a simple push of a button ([STAY] or [NIGHT]) on the F-TPBR Touchpad control module. To disarm, simply Press the Disarm/Silence button.

The F-TPBR Touchpad's integral wide-angle PIR motion sensor acts as an occupancy sensor that provides the microprocessor with activity information which prevents the user from making errors during the arming and disarming periods. In addition, the F-TPBR Touchpad PIR will provide interior

intrusion protection when the system is armed in the AWAY mode. During an entry delay or an alarm, the system may only be disarmed and silenced by inserting the F-IFOB digital key into the F-IFOB slot on the F-TPBR Touchpad or F-TP Touchpad.

By allowing this level of system control without traditional numeric keypad interaction, the Freedom

System will provide a significant reduction in false alarms due to user error and also provide comfortable use of the system to those customers whose technophobic tendencies would prevent them from arming and disarming the system using a traditional keypad.

The Freedom System also prevents the arming of the alarm system if all deadbolts are not engaged, a high security feature normally found only in very elaborate high-end installations.

INSTALLATION

The F-TPBR Touchpad need only be mounted and wired to the existing Freedom system. The Freedom system can only support two F-TP Touchpads or one F-TP Touchpad and one F-TPBR Touchpad.

POWER

The F-TPBR Touchpad is powered by the keypad bus of the F-8 Panel. Each F-TPBR Touchpad draws 55mA and an additional 20mA in alarm. Deduct these values from the system standby and alarm current, as described in the wiring diagram.



This manual contains the Installation Instructions for the Freedom F-TPBR Touchpad. It is intended to be used in conjunction with the Freedom F-8 Panel Installation Instructions (WI1431) and the Freedom F-8 Panel Programming Instructions (WI1432).

F-TPBR Touchpad Wiring Diagram

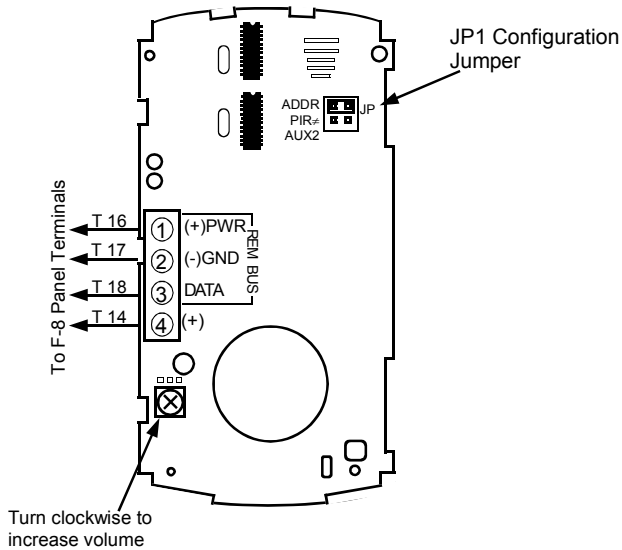

F-TPBR Touchpad Configuration Jumper JP1

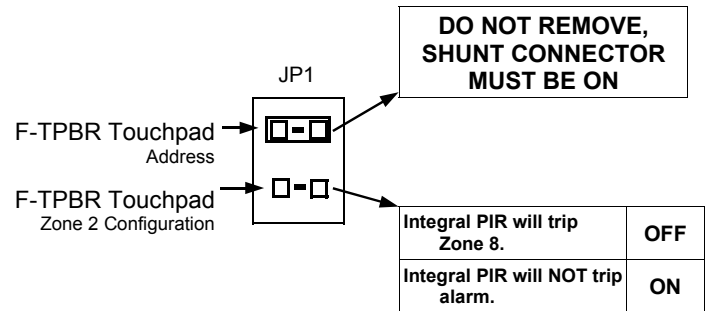

Touchpad Addresses

The F-TPBR Touchpad jumper is installed at the factory--Do Not Remove. The system requires an F-TP Touchpad configured for address number 1 (no shunt on address jumper).

F-TPBR System Zones

The F-TPBR provides 2 additional system zones.

F-TPBR Zone 1 may be used as a wireless zone and will report and display as system Zone 7. Zone 2 is the integral PIR of the F-TPBR which will report and display as system Zone 8.

F-TPBR Touchpad Zone 1 Configuration.

To enable wireless on Zone 7, program "Dealer Options 2" location with a 3, i.e., [97-3].

F-TPBR Touchpad Zone 2 Configuration.

By default (JP1.2 not installed), the F-TPBR Touchpad's integral PIR is configured as Zone 8. A violation of the F-TPBR Touchpad PIR will cause a Zone 8 alarm if armed AWAY.

If JP1.2 jumper is installed, the integral PIR will not activate an alarm. In this configuration, the F-TPBR Touchpad PIR will function only as an activity sensor (preventing false alarms when erroneously armed AWAY) and will not provide any protective burglary functions.

F-TPBR Touchpad Terminal Descriptions

Terminals 1-3: F-TPBR Touchpad Data Bus Terminals

The F-TPBR Touchpad communicates to the F-8 Panel via the F-8 Panel's 3-wire keypad bus. Wire the F-TPBR Touchpad to the F-8 Panel as shown on wiring diagram. Terminal 1 is + 12 V DC, Term 2 is GND and Term 3 is Data.

Terminal 4: Alarm Output

The F-TPBR Touchpad has an integral sounder, but unlike the F-TP Touchpad, the sounder *does not* meet (even at full volume) the NFPA audible requirement of 85dB @ 10 feet for residential fire or residential burglary. **NOTE:** In UL Residential Fire and NFPA installations, the F-TPBR Touchpad **must not** have the bell terminal connected, as connection would prevent the supervision of the F-TP Touchpad bell.

Alarm Sounder Volume Adjustment

The F-TPBR Touchpad alarm circuit includes a potentiometer which regulates the volume of the sounder. The sounder volume is set at the factory to the minimum level (fully counter-clockwise) and can be increased to satisfy the requirements of the installation. Turn the potentiometer clockwise to increase the volume or remove the wire from terminal 4 of the F-TPBR Touchpad to silence.

Emergency Button Decals

Position as follows:

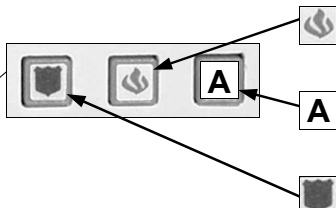

Flame = Fire Emergency (apply to middle button).

A = Auxiliary Emergency (optional) (apply to right button).

Shield = Police Emergency (apply to left button).

Installing the Freedom F-TPBR Touchpad

Care should be taken to select a mounting area that provides a proper field of view for the PIR sensor. See page 4 for more information. The following instructions illustrate the steps required for installation of the F-TPBR Touchpad.

- 1 Open the F-TPBR Touchpad.** Remove the front of the F-TPBR Touchpad housing by inserting a screwdriver into the (2) slots in the bottom of pad.

Push the screwdriver up and gently twist to unhook the plastic tabs which secure the face of the F-TPBR Touchpad to its base.



- 2 Mark the holes.** Mount anywhere in a room with a favorable PIR field of view, approximately 60" high (measured from the floor to the top of the F-TPBR Touchpad).

Affix the template to the wall and mark or punch through the 4 oval mounting holes and the wire access opening.

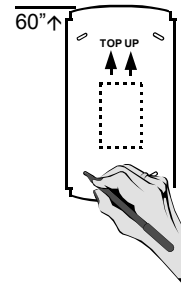

- 3 Cut access hole** Install (4) wall anchors and cut access hole in wall.

Pull 4 conductor bus wire from F-8 Panel into opening.

Warning: Use caution when cutting holes. There may be high voltage wiring in wall.

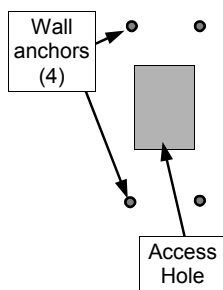

- 4 Make Connections and Create Service Loop**

Punch holes with an awl in the F-TPBR Touchpad base fitting the wire sizes used and pull wires through base. Secure base to wall. Wire to F-TPBR Touchpad using wiring diagram as a guide.

Push all excess wire back into wall leaving a short loop (about 3"-4") of slack wires for service purposes.

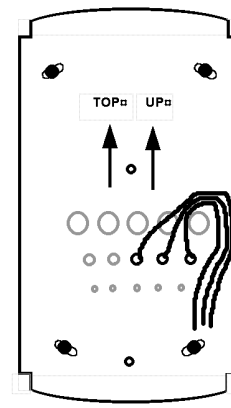

- 5 Seal access holes--IMPORTANT:**

After creating your service loop of wires, seal the access holes with putty (supplied) to ensure F-TPBR Touchpad is air tight. This important step is necessary to prevent air drafts from entering the F-TPBR Touchpad from the wall cavity.

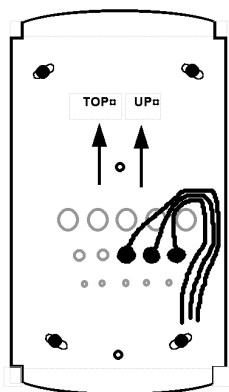

- 6 Install the F-TPBR Touchpad Face**

Double-check all connections to the F-TPBR Touchpad using the wiring diagram as a guide. Snap the front of the F-TPBR Touchpad onto the base by first inserting the 2 slots in the top onto the corresponding tabs on the base and then snapping the bottom into place.



TOUCHPAD PIR

The F-TPBR TOUCHPAD includes an integral PIR sensor which provides the following system functions:

Activity Sensor

The PIR is always gathering activity information which provides the system with data that is used to insure proper use of the system and prevent user errors. For example, if the user arms AWAY and the F-TPBR TOUCHPAD senses movement in the room within 1 minute after arming AWAY, the system will automatically default to STAY mode arming, preventing a false alarm. If additional PIR sensors are installed, the activity of these sensors will also be included in these decision making processes.

Intrusion Protection Device

When the system is armed AWAY, the PIR provides intrusion protection with a range of 25' at a 90° pattern of protection. An intruder detected in this protected area will cause a Zone 8 alarm with a corresponding central station report and audible alarm. **NOTE:** If Touchpad PIR Intrusion Protection is not desired, it may be disabled by installing configuration jumper JP1.2.

Pet Protection

The F-TPBR Touchpad is provided with a Pet Alley Lens installed, creating a low-sensitivity zone close to the ground that will not detect pets under 24" in height. **Note:** For installations with pets, additional perimeter and/or interior protection may be required to ensure system integrity.

Protection Pattern

The diagrams at right illustrate the Pet Alley pattern of protection. The *Side View* pattern of protection illustrated reflects an F-TPBR Touchpad installation height of 5 feet.

IMPORTANT: If the F-TPBR TOUCHPAD can be accessed from an area that is not protected by the pattern of protection provided by the Touchpad PIR, then additional protection is required. This may include protecting other doors and windows or additional space protection.

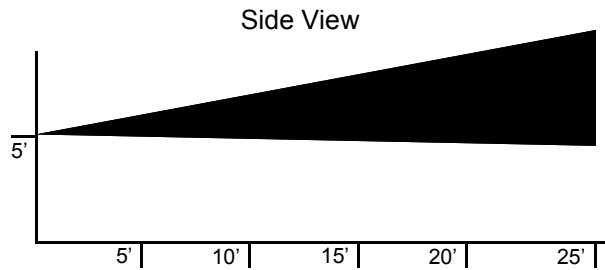
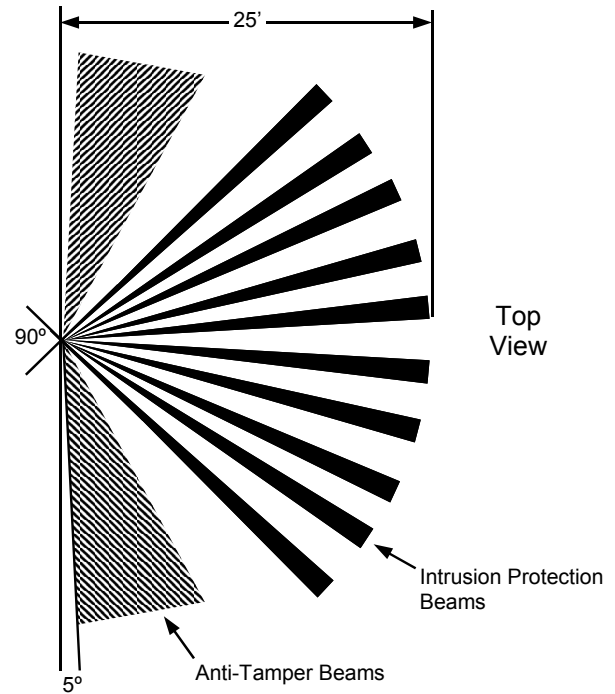

Changing the Lens

In the event that the lens must be changed, use the following procedure:

1 Power-down the system and remove the front of the F-TPBR Touchpad housing. With the F-TPBR Touchpad disconnected, the following steps can be performed with greater ease.

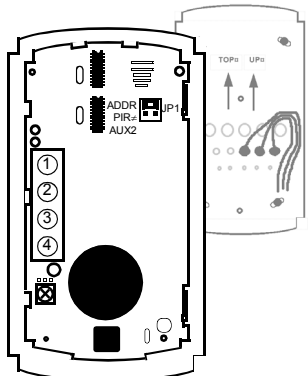

2 In the center of the PC board is a speaker, with black and red wires connected to a plug mated to a receptacle. Remove the speaker plug by pushing back the retainer latch on the receptacle using a small screwdriver and carefully pulling plug out of the receptacle.

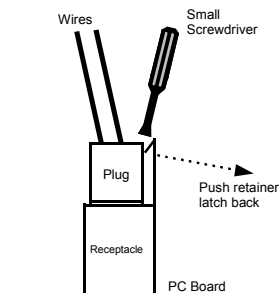

3

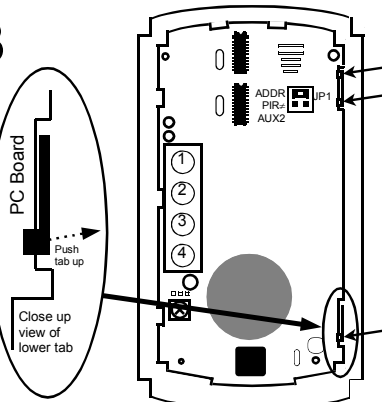

Remove the PC Board by bending back 3 tabs holding the PC board in place. Pull board up slightly and away from opposite side of F-TPBR Touchpad housing to remove.

4 Snap out lens holder with small screwdriver and pull out existing lens. Replace with the Pet Alley lens so that the notch (as viewed from back of case) is in the bottom right position. (The Pet Alley lens was installed at the factory when manufactured).

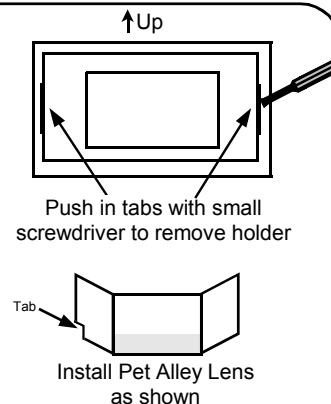

5

Secure lens by snapping the PIR lens holder back into place. Be sure both tabs are securely fastened to the F-TPBR Touchpad housing. **Note:** Be sure grooved side of lens is facing in (smooth side is facing out).

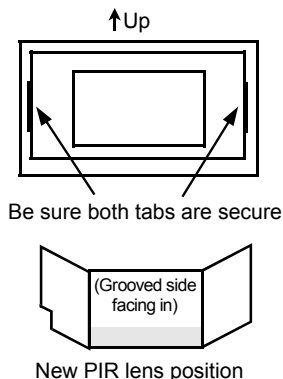

6

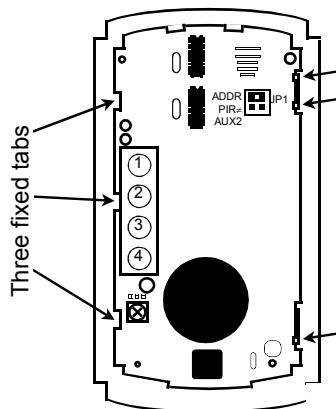

Reinstall PC board by first sliding the board under three fixed tabs on the left side of the housing. Then push board under the three movable tabs until it snaps securely into place.

7

Re-connect speaker by pushing plug back into receptacle. Be sure the speaker plug is fully pushed into receptacle allowing retainer latch to secure the plug.

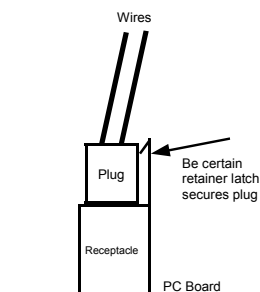

8 Install the F-TPBR Touchpad Face

Snap the front of the F-TPBR Touchpad onto the base by first inserting the 2 slots in the top onto the corresponding tabs on the base and then snapping the bottom into place.

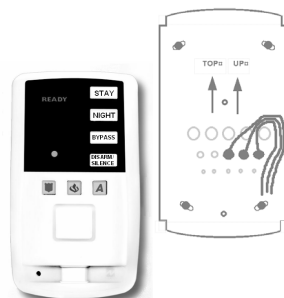

Adjusting the Freedom F-TPBR Touchpad Sounder Volume

The F-TPBR Touchpad alarm circuit includes a potentiometer which regulates the volume of the sounder. The sounder volume is set at the factory to the minimum level (fully counter-clockwise) and can be increased to satisfy the requirements of the installation. Adjust the volume as follows:

- 1 After all components of the system are installed and fully functioning,** determine if the volume of the F-TPBR Touchpad sounder is sufficient. The volume is set to the lowest level at the factory, and if you determine it should be increased, continue with the following steps.



Check volume with the F-TPBR Touchpad fully installed and mounted.

- 2 To keep siren on continuously,** temporarily rewire the F-8 Panel as follows: Remove the F-TPBR Touchpad yellow wire from terminal 14 (+Bell) and connect to terminal 16 (+PWR). **NOTE:** The F-TPBR Touchpad yellow wire is connected to terminal 4 of the F-TPBR Touchpad. See wiring diagram for wiring overview.

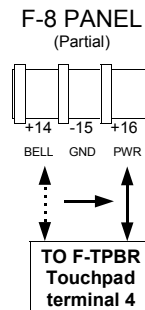

- 3 Open the F-TPBR Touchpad.** Remove the front of the F-TPBR Touchpad housing by inserting a screwdriver into the (2) slots in the bottom of pad.



Push the screwdriver up and gently twist to unhook the plastic tabs which secure the face of the F-TPBR Touchpad to its base.

Push tabs up and twist

- 4 On the circuit board,** adjust the sounder volume. Using a small Phillips-head screwdriver, turn the potentiometer clockwise to increase the volume until desired the level is reached.

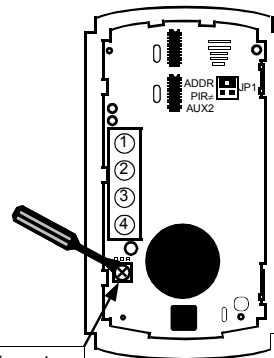

Potentiometer

- 5 Re-install the F-TPBR Touchpad Face**

To be certain the sounder is adjusted correctly, re-install the F-TPBR Touchpad face. Snap the front of the F-TPBR Touchpad onto the base by first inserting the 2 slots in the top onto the corresponding tabs and then snapping the bottom into place.



- 6 Listen to the F-TPBR Touchpad sounder** from various areas of the room.

If further adjustment of the sounder volume is required, repeat steps 3-6 as needed.

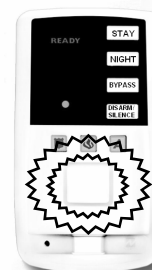

- 7 Turn off siren.** Rewire the F-8 Panel as follows: Remove the F-TPBR Touchpad yellow wire from terminal 16 (+PWR) and permanently reconnect to terminal 14 (+Bell). **NOTE:** The F-TPBR Touchpad yellow wire is connected to terminal 4 of the F-TPBR Touchpad. See wiring diagram for wiring overview.

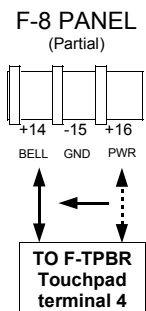

- 8 Install the F-TPBR Touchpad Face**

Double-check all connections to the F-TPBR Touchpad using the wiring diagram as a guide. Be sure all access holes are sealed with putty to ensure F-TPBR Touchpad is air tight. Snap the front of the F-TPBR Touchpad onto the base by first inserting the 2 slots in the top onto the corresponding tabs and then snapping the bottom into place.



SYSTEM OVERVIEW

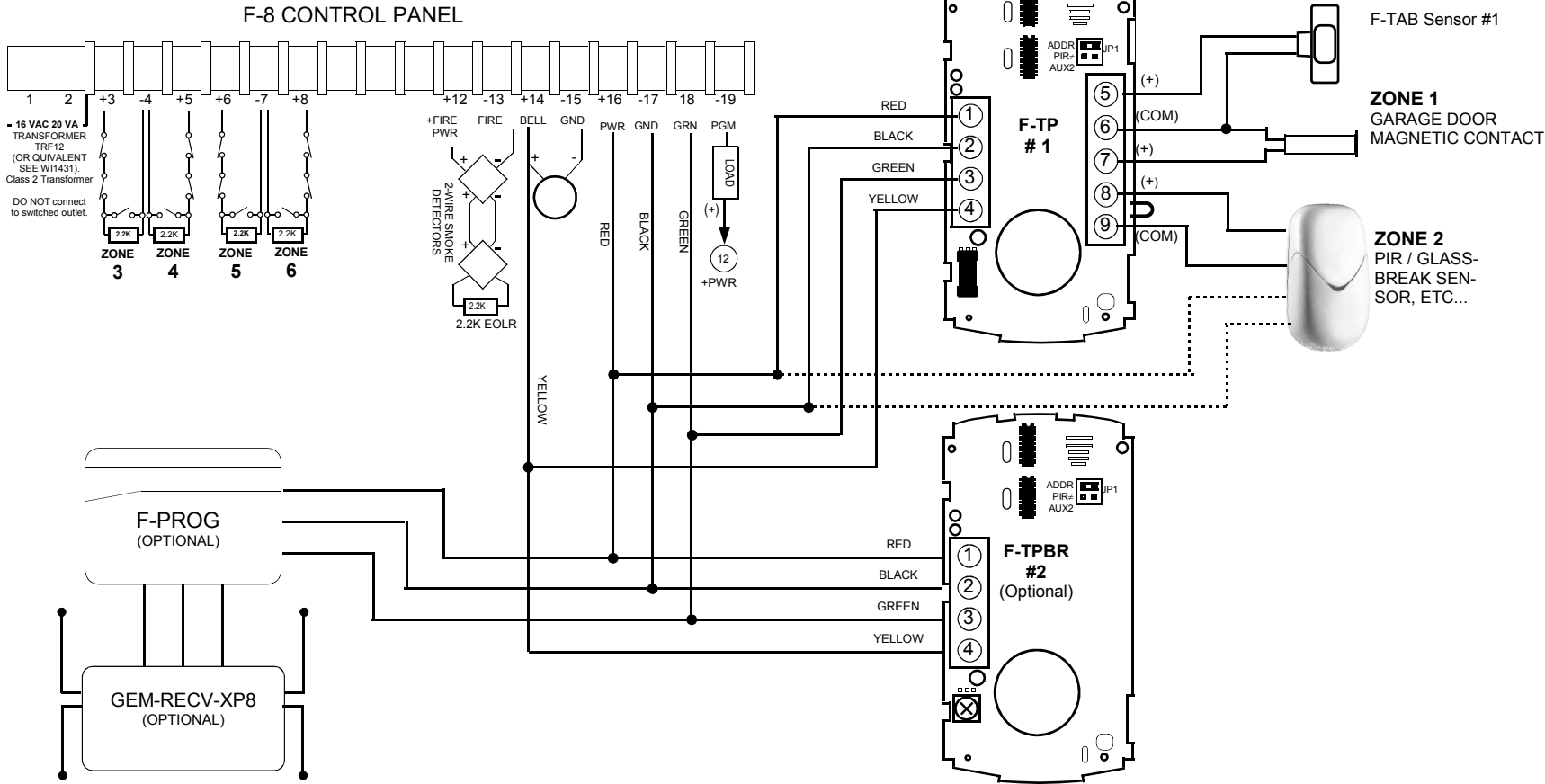

MOUNTING TEMPLATE

